

INSTRUCTION MANUAL ROTATING LASER

RT-5SW

FCC WARNING

Changes or modifications not expressly approved by the manufacturer for compliance could void the user's authority to operate the equipment.

In order to comply with FCC radio-frequency radiation exposure guidelines for an uncontrolled exposure, this device and its antenna must not be co-located or operating in conjunction with any other antenna or transmitter.

The term "IC:" before the radio certification number only signifies that Industry Canada technical specifications were met.

"Operation of this device is subject to the following two conditions: (1) this device may not cause interference, and (2) this device must accept any interference, including interference that may cause undesired operation of the device."

"The installer of this radio equipment must ensure that the antenna is located or pointed such that it does not emit RF field in excess of Health Canada limits for the general population; consult Safety Code 6, obtainable from Health Canada's website www.hc-sc.gc.ca/rpb".

Declaration of Conformity

Model Number:	RT-5SW/RC-300W
Trade Name:	TOPCON CORPORATION
Responsible party:	TOPCON POSITIONING SYSTEMS,Inc.
Address:	7400 National Drive,Livermore, CA 94551, U.S.A.
Telephone number:	925-245-8300

This device complies with Part 15 of the FCC Rules. Operation is subject to the following two conditions: (1) This device may not cause harmful interference, and (2) this device must accept any interference received, including interference that may cause undesired operation.

Foreword

Thank you for purchasing the Topcon RT-5SW Rotating Laser.

It is one the world's most advanced and accurate grade-setting lasers. To quickly and effectively use the RT-5SW, please read these brief instructions carefully, and keep them in a convenient location for future reference.

Handling Precautions

Guarding the instrument against shock

When transporting the instrument, provide some protection to minimize risk of shock. Heavy shocks may affect beam accuracy.



Caution:

Use of of adjustment controls or performance procedures other than those specified herein may results in hazardous radiation exposure.

Safety Information

In order to encourage the safe use of products and prevent any danger to the operator and others or damage to properties, important warnings are put on the products and inserted in the instruction manuals.

We suggest that everyone understand the meaning of the following displays and icons before reading the “Safety Cautions” and text.

Display	Meaning
 WARNING	Ignoring or disregard of this display may lead to death or serious injury.
 CAUTION	Ignoring or disregard of this display may lead to personal injury or physical damage to the instrument.

- Injury refers to hurt, burn, electric shock, etc.
- Physical damage refers to extensive damage to buildings or equipment and furniture.

The user of this product is expected to follow all operating instructions and make periodic checks of the product's performance. The manufacturer or its representatives assume no responsibility for results of the use of this product including any direct, indirect, consequential damage, and loss of profits.

Safety Cautions



WARNING

There is a risk of fire, electric shock or physical harm if you attempt to disassemble or repair the instrument yourself.

This is only to be carried out by TOPCON or an authorized dealer,only!

Laser beams can be dangerous, and can cause eye injury if used incorrectly .

Never attempt to repair the instrument yourself.

Laser beams can be dangerous. They can cause eye injury.

Do not stare into beam.

High temperature may cause fire.

Do not cover the charger while it is charging.

Risk of fire or electric shock.

Do not use damaged power cable, plug and socket.

Risk of fire or electric shock.

Do not use a wet battery or charger.

May ignite explosively.

Never use an instrument near flammable gas, liquid matter, and do not use in a coal mine.

Battery can cause explosion or injury.

Do not dispose in fire or heat.

Risk of fire or electric shock.

Do not use any power voltage except the one given on manufacturers instructions.

Battery can cause outbreak of fire.

Do not use any other type of charger other than the one specified.

The short circuit of a battery can cause a fire.

Do not short circuit battery when storing it.



CAUTION

Use of controls or adjustment or performance of procedures other than those specified herein may result in hazardous radiation exposure.

Do not connect or disconnect equipment with wet hands, you are at risk of electric shocks if you do!

Risk of injury by overturn the carrying case.

Do not stand or sit on the carrying cases.

Please note that the tips of tripod can be hazardous, be aware of this when setting up or carrying the tripod.

Risk of injury by falling down the instrument or case.

Do not use a carrying case with a damaged which belts, grips or latches.

Do not allow skin or clothing to come into contact with acid from the batteries, if this does occur then wash off with copious amounts of water and seek medical advice.

It could be dangerous if the instrument falls over, please check that you fix the instrument to the tripod correctly.

Risk of injury by falling down a tripod and an instrument.

Always check that the screws of tripod are tightened.

EXCEPTIONS FROM RESPONSIBILITY

- 1) The user of this product is expected to follow all operating instructions and make periodic checks of the product's performance.
- 2) The manufacturer, or its representatives, assumes no responsibility for results of a faulty or intentional usage or misuse including any direct, indirect, consequential damage, and loss of profits.
- 3) The manufacturer, or its representatives, assumes no responsibility for consequential damage, and loss of profits by any disaster, (an earthquake, storms, floods etc.).
A fire, accident, or an act of a third party and/or a usage any other usual conditions.
- 4) The manufacturer, or its representatives, assumes no responsibility for any damage, and loss of profits due to a change of data, loss of data, an interruption of business etc., caused by using the product or an unusable product.
- 5) The manufacturer, or its representatives, assumes no responsibility for any damage, and loss of profits caused by usage except for explained in the user manual.
- 6) The manufacturer, or its representatives, assumes no responsibility for damage caused by wrong movement, or action due to connecting with other products.

WARNING : Handling the cord on this product or cords associated with accessories sold with this product, will expose you to lead, a chemical known to the State of California to cause birth defects or other reproductive harm. ***Wash hands after handling.***

Laser Safety

Safety Information

This laser complies with all applicable portions of title 21 of the Code of Federal Regulations, Dept. of Health, Education, and Welfare: Food and Drug Administration: Center for Devices : Bureau of Radiological Health.

Do not stare into the laser beam or view directly with optical instruments.

Do not disassemble the instrument or attempt to perform any internal servicing.

Repair and servicing of this laser are to be performed by TOPCON or its authorized dealer.

Caution : Use of adjustment controls or performance procedures other than those specified herein may result in hazardous radiation exposure.

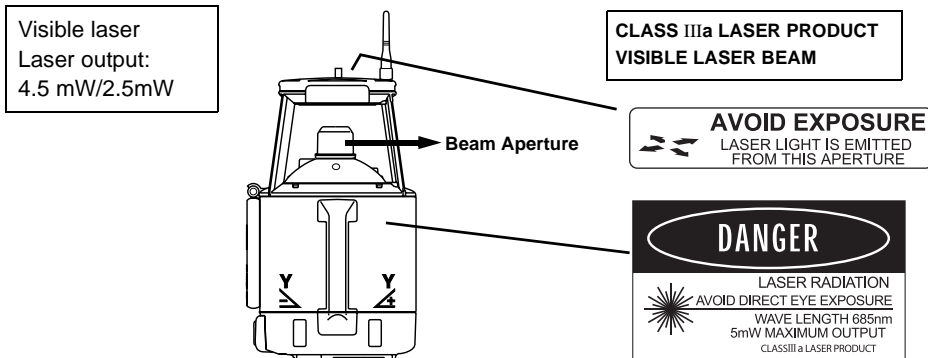

Contents

Foreword	1
Handling Precautions	1
Safety Information	2
Safety Cautions	3
Laser Safety	6
Contents	7
Standard System Components	9
Nomenclature	10
Sample Display	11
Key Functions	12
Basic Operation	13
Preparation and Functions	14
Power Source	14
Setting Instrument Up	14
RC-300W Remote Controller	15
Power Switch	17
Battery Status Display	19
Setting Grades	20
How to enter grade	21
Automatic Alignment	22
Executing Automatic alignment	24
Automatic grade setting	25
Executing Automatic grade setting	25
Single axis	26

Dual axes	26
How to change the rotary head speed (300, 600, 900 R.P.M.)	28
Height Alert function	28
RT-5SW LED display	29
Masking (Laser beam shutter)	30
Change the masking mode	31
Function Mode	33
How to set the options	37
Maintaining Power Sources	39
RC-300W	39
RT-5SW	40
Dry battery	40
Rechargeable battery	41
Check and Adjusting	43
Horizontal Calibration	43
Horizontal Rotation Cone Error.....	48
Grade Setting Error.....	49
Storage Precautions.....	51
Standard / Optional Accessories.....	52
Specifications	57
Error Display	59

Standard System Components

- 1) Instrument 1pc.
- 2) Level sensor LS-70A..... 1pc.
- 3) Level sensor holder model 6 1pc.
- 4) Target 1pc.
- 5) Carrying case 1pc.
- 6) Instruction manual..... 1vol.
- 7) Battery holder DB-64C 1pc.
- 8) Ni-MH battery pack BT-63Q 1pc.
- 9) AC/DC converter AD-9B/7C..... 1pc.

- Please make sure that all of above items are in the box when you unpack.

Nomenclature

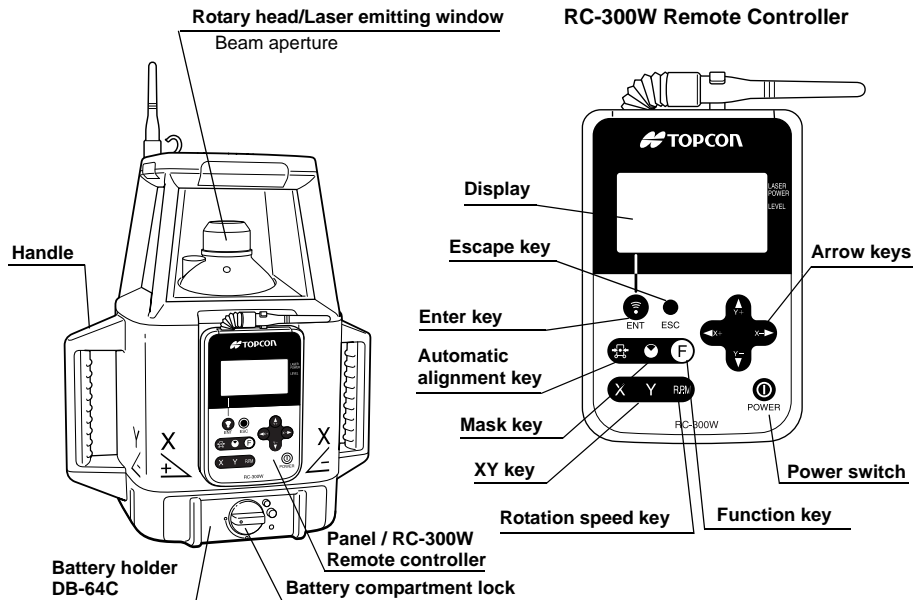

Sample Display

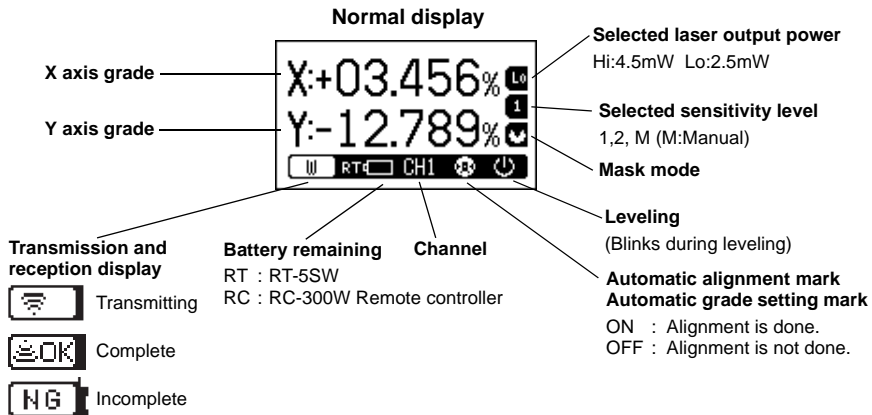

Function mode

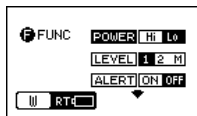

Automatic alignment mode

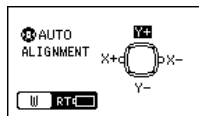



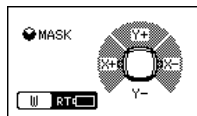



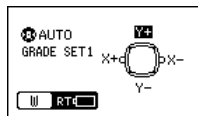

Mask mode



Automatic grade setting mode

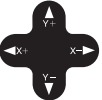

Key Functions

	Enter key	End Operation of Data Input and Sends data to the instrument.
	Escape key	Cancels input or Escape to Previous status.
	Automatic alignment/ Automatic grade set key	Executes Automatic alignment / Automatic grade set mode.
	Mask key (Beam shutter)	Sets the laser mask (shutter).
	Function key	Function mode. The following functions can be set. Laser output power/ Sensitivity level/ Height Alert/ Alarm signal / Masking mode/ Setting the target/ Channel setting
	XY key	Sets each grade axis.
	Speed key	Changes the rotary head speed. 300/600/900 r.p.m.
	Arrow keys	Changes the function page / Selects the items. Inputs the grades of X Y axis. Sets the masking direction.
	Power switch	On/Off of the RT-5SW and RC-300W. (RC-300W has auto-cut off 60 seconds function)

Basic Operation

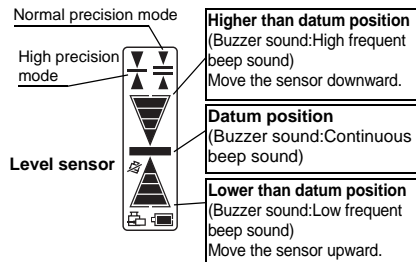
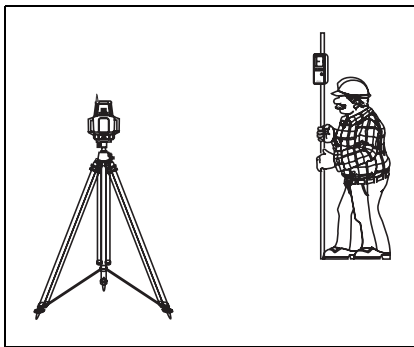

- 1** Set the instrument on a tripod or smooth surface and power ON.

If you want to use RC-300W for remote control, remove it from the instrument and power on.

To precisely align the instrument, use the Automatic alignment function. See “Automatic Alignment” and “Executing Automatic alignment” sections.

- 2** Set X and/or Y axis grades.
- 3** Turn on LS-70A level sensor. Check the operation surface by using the LS-70A level sensor. If high-precision detection is desired, select that setting on the LS-70A.
(For more information about LS-70A level sensor refer to “Standard / Optional Accessories” section.)
- 4** Check the rotating beam elevation using the LS-70A level sensor.

Preparation and Functions

Power Source

Connect the battery according to the battery type purchased.

For charging and battery replacement instructions, see the “Maintaining Power sources” section.

Setting Instrument Up

Set the instrument on a tripod or smooth surface.

The instrument must be within horizontal ± 5 degrees of true level for auto-leveling to operate.

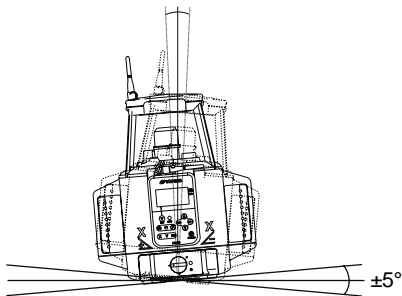

When using the remote controller attached to the device, lower the remote controller antenna.

RC-300W Remote Controller

The panel of the instrument can be removed for wireless remote controller RC-300W. To remove the RC-300W, first push it up then pull it straight away from the instrument.



When using the remote controller, raise the remote controller antenna.

Operating the RC-300W

The RC-300W will always operate the RT-5SW while attached to the unit. It will also operate the RT-5SW remotely when detached from the instrument.

The RC-300W both sends and receives information from the RT-5SW when it is used within 300m(984ft) of the instrument.

When attached to the RT-5SW, the RC-300W receives its power from the instrument. In remote operation, the RC-300W must have batteries installed. See “Maintaining Power Sources” section.

When entering information in the RC-300W, you must always press the [ENT] key to send the information to the RT-5SW.

The [OK] indicator is displayed on the RC-300W LCD to confirm communication with the RT-5SW. If communication fails, [NG] is displayed.

The remote control will automatically turn off about 60 seconds after the last time any key is pressed or after leveling is completed (auto cut off function). To reactivate the RC-300W, press the power switch once.

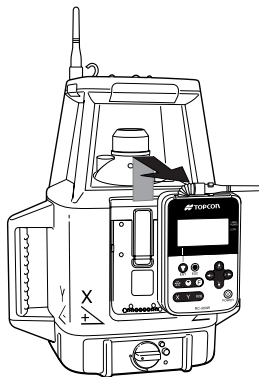

Transmission and reception display



Transmitting



Complete



Incomplete



- 1) The working range of the remote controller is up to a distance of about 300 m from the instrument.
- 2) It is necessary to install batteries when using the remote controller. Install the batteries by referring to “Maintaining Power Sources” on page 39. The power supply of the remote controller is drawn from the instrument when attached.
- 3) The power of the remote controller shuts off automatically after about 60 seconds when key or leveling operations have been completed (Auto Shutoff Function). Press the power switch once to restore power to the remote controller after the auto shutoff function has been activated.

Common use of RC-300W remote controller

RC-300W remote controller is available for number of RT-5SW. When you are using plural RT-5SW at your job site, you can use your RC-300W for the other RT-5SW unit. Change the channel to receive the internal data of each RT-5SW to the RC-300W by operating the RC-300W.

This function enables to operate RC-300W without re-attach to every RT-5SW which you are using. The data of each unit can be transmitted to the RC-300W before operating.

See page 35 for the operation “7) Channel Setting”.

Power Switch

Turn the instrument ON or OFF by pressing the power switch on the RC-300W.

Auto-leveling and grade setting will begin.

When using the RC-300W for wireless remote control, also turn the instrument ON or OFF by pressing the power switch on the RC-300W.

The following screen will appear if the RT-5SW did not receive the power on signal. Press the power switch again.

The channel on the RT-5SW does not agree with that on the RC-300W (Remote mode).

- 1** If the channel on the main unit is different from that on the remote control when the power switch is turned ON, the channel on the main unit will be automatically searched for. [SEARCHING...] will be displayed.
- 2** When the search is finished, the available channels will be displayed. Use the arrow key (up and down) to position the cursor on the channel you want to select and then press the [ENT] key to establish that channel.

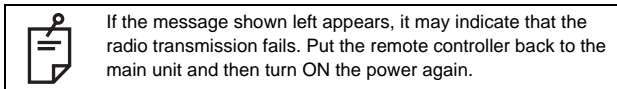
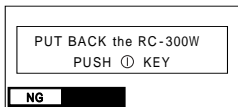

Powering ON/OFF while in Automatic alignment mode

If the Automatic alignment / Automatic grade setting function has been used to precisely align the grade axis, the alignment setting is maintained when the instrument is turned off. This allows you to turn off the RT-5SW to save power during non-use times without the need to re-align when the unit is turned back on.

When power is turned back on after Automatic alignment, the following display will be shown. Press the allow keys to select No or YES, then press the [ENT] key. NO maintains the current alignment setting. YES clears the alignment and returns the instrument to the default XY alignment. (see “Automatic Alignment” and “Executing Automatic Alignment” sections.)

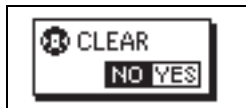

Battery Status Display

Battery status is shown in the lower bar of the remote controller display.

When the remote controller is mounted to the RT-5SW, the battery status is for the RT-5SW only.

When the remote controller is removed from the RT-5SW, the battery status for the remote controller is displayed. When the RT-5SW is turned on with the remote controller, the battery status for the RT-5SW is displayed for about five seconds.



Battery remaining display

RT : RT-5SW
RC : RC-300W



Battery is sufficient.



Battery is sufficient.



Battery is sufficient.



The power is low, but laser is still usable. (Indication continues until batteries are dead.)

**RT BATT LOW
or
RC BATT LOW**

Dead batteries of RT-5SW or RC-300W. Recharge the battery or replace the dry batteries with new ones.

Error display

RT BATT LOW : Dead batteries of RT-5SW
RC BATT LOW : Dead batteries of RC-300W



Even if an AC/DC converter is connected at this time, error display still continues. Once the power is turned off, the battery remaining display will reset.

For handling batteries, see the “Handling Power sources” chapter.

Setting Grades

Grade can be set in both axes, X and Y, as shown below.

X: -10% ~ +10%

Y: -25% ~ +25%

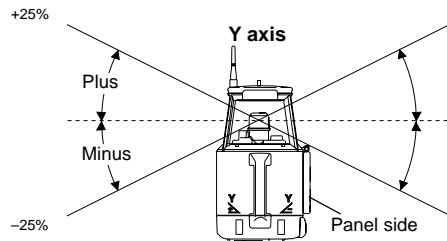
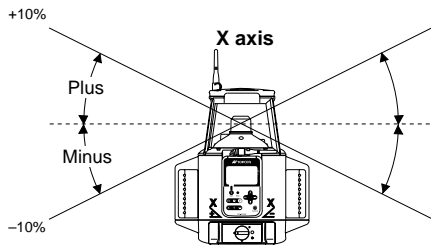

Single axis

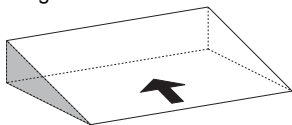

Grade range:
X: -10%~+10%
or
Y: -25%~+25%

Dual axes

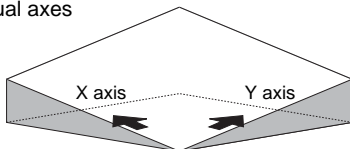

Grade range:
X: -10%~+10%
Y: -25%~+25%

How to enter grade

- 1 Press the X or Y key to begin grade input.
The plus or minus symbol of the axis selected will flash.
- 2 Select positive or negative grade by pressing arrow keys (Up or Down).
- 3 Move the cursor by pressing the arrow keys (Right or Left).
- 4 Increase or decrease the number by pressing the arrow keys (Up or Down).
- 5 Repeat steps 3 to 4 to set the grade you desire.
- 6 Press the [ENT] key to finish input.
Confirm the [OK].
If the [NG] mark is displayed, press the [ENT] key.



The displayed value can be reset to 00.000% by holding down the [X] or [Y] key for several seconds.

Automatic Alignment

Automatic Alignment makes precise grade axis alignment very easy.

To prepare the instrument for Automatic alignment, X and Y axes must be roughly aligned to within 10 degrees of the true axis desired. This can be done by using the molded sights of top of the instrument housing.

The RT-5SW alignment target is then positioned directly on the grade axis desired up to 150 meters (492 ft) away from the instrument.

Instrument as seen from above

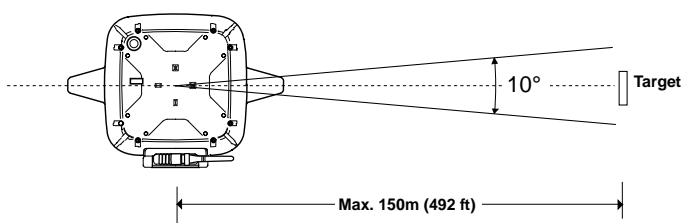

Target

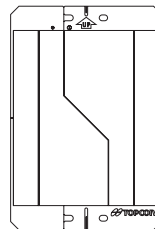

- 1) The maximum distance the target can be away from the RT-5SW is 150m (492ft).
- 2) The target must be positioned so it is centered on the grade axis desired and UP arrow is facing up.
- 3) The reflective side of the target must face the RT-5SW.

Using the target

Hang the hook located on the rear.

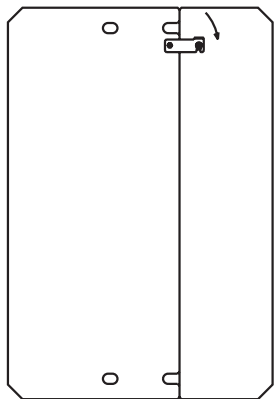

Executing Automatic alignment

Set the alignment target. Since the range over which the grade is set automatically is within about 10° of the width in the X and Y directions of the instrument, place the instrument so as to be within that range

- 1 Press the Automatic alignment key on the RC-300W. Select [ALIGNMENT] and press the [ENT] key to finish input.
- 2 Using the arrow keys, select the grade axes that is roughly aligned to the alignment target (Y+, X-, Y-, X+). Press the [ENT] key to finish input.
- 3 Begin auto-alignment after transmission completed. You will know transmission has been received as the scanning laser will be activated and starts searching for the target. If the error code [RETRY] is displayed, make sure the alignment target and instrument are correctly positioned as described in the previous section, type of the target, and repeat the above procedure from step 1.

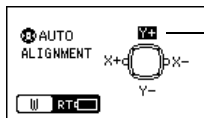
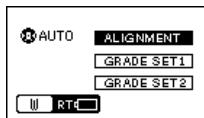

Highlight indicates grade axis selected.

Sample display : Y + direction is selected.

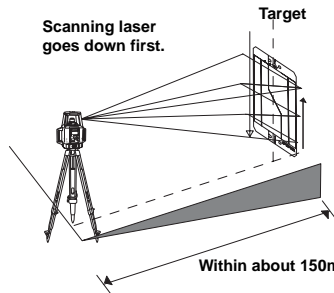

The scanning laser locates the center of the target then the RT-5SW precisely adjusts its grade axis to that location.

Automatic grade setting

In order to obtain the accurate grade value, first perform the Automatic alignment, measure the direction of the target, and then automatically set the grade.

For the Dual axes setting, specify the reference direction for the 1st axis. To prepare the instrument for Automatic grade setting, X and Y axes must be roughly aligned to within 10° of the true axis desired. This can be done by using the molded sights of top of the instrument housing.

Executing Automatic grade setting

Since the range over which the grade is set automatically is within about 10° of the width in the X and Y directions of the instrument, place the instrument so as to be within that range. In addition, since the Automatic grade setting range is $\pm 5^\circ$, use the instrument within that range.

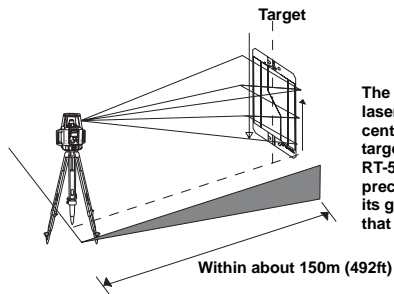

The scanning laser locates the center of the target then the RT-5SW precisely adjusts its grade axis to that location.

Single axis

- 1** Press the Auto-alignment key on the RC-300W, select [GRADE SET 1] and press the [ENT] key to finish input.
- 2** Using the arrow keys, select the grade axis that is roughly aligned to the alignment target (Y+, X-, Y-, X+). Press the [ENT] key to finish input.
- 3** During the grade setting, [PROCESSING ...] is displayed. After the grade setting is finished, the one-axis setting will be displayed (normal display).

Dual axes

- 1** Press the Auto-alignment key on the RC-300W, select [GRADE SET 2] and press the [ENT] key to finish input.
- 2** Using the arrow keys, select the 1st axis that is roughly aligned to the alignment target (Y+, X-, Y-, X+). Press the [ENT] key to finish input. During the grade setting for the 1st axis, [1st PROCESSING ...] is displayed.
- 3** When the setting for the 1st axis is finished, the 2nd axis setup screen will appear. Use the arrow key (Y+, X-, Y-, X+) to select the direction of the 2nd axis and then press the [ENT] key to establish that direction.
During the grade setting for the 2nd axis, [2nd PROCESSING ...] is displayed. After the grade setting is finished, Dual axes grade display will appear (normal display).



If the tilt error of the main unit is excessive, an error may occur during the grade setting. The stability can be further improved by making an adjustment through calibration so as to minimize the error of the main unit and then using the grade setting mode.



If the target tilts to left or right, an error will occur in the height from the ground to the index. In order to obtain the accurate height of laser beam, use the value calculated by averaging the heights from the ground to the left and right indexes.



"CHECK the AXIS" is displayed when the same axes have been set when the instrument is set to dual axes. Reset the axes when this message is displayed.

If the [ESC] key is pressed during the Automatic alignment or the Automatic grade setting:



NO : Continue
YES: Break off

How to change the rotary head speed (300, 600, 900 R.P.M.)

The rotary head speed can be set to 300,600 or 900 R.P.M.

- 1 Press the [R.P.M] key on the RC-300W. The head speed display will flash.
- 2 Select the desired speed using the arrow keys, then press the [ENT] key.



Head speed

Height Alert function

This is an optional setting that must be activated by the user. When active, the Height Alert function will not allow the RT-5SW to continue operating if the unit is disturbed after it has auto-leveled. This reminds the user that to insure accurate control, the height of the beam should re-checked after the unit has been disturbed.

If the function is active and the unit is disturbed, the red LED visible when the RC-300W is removed will blink rapidly. To re-activate auto-leveling, turn the power key OFF and ON again. After auto-leveling is complete check the beam elevation using the LS-70A to confirm it has not changed.



If the Alarm Signal [COM] function is also active when the Height Alert function is active, the rotary head will continue to rotate to communicate the alert to the LS-70A laser sensor.

RT-5SW LED display

(visible when RC-300W is removed)

When the RC-300W is detached from the unit, a LED is visible. It provides a quick status check on the RT-5SW as follows:

Yellow flashing:

Auto-leveling or grade setting is in process.
The rotary head is not rotating.

Yellow ON solid:

Auto-leveling grade setting is complete.
The rotary head is active and emits the laser beam.

Red quick flashing:

- 1) The instrument is positioned beyond auto-leveling range ($\pm 5^\circ$).
Reposition the instrument into range and LED should begin normal flashing.
- 2) Error has occurred. If Height Alert function is active, unit may have been disturbed (see previous section). RC-300W will also indicate error code.
See “Error Display” section.

Red flashing:

Indicates the current channel on the remote control for the instrument. The channel on the instrument can be identified from the number of blinking times after long illumination.



You can stop the auto-levelling function. Refer to “Function Mode” on page 33 to stop the function.

Masking (Laser beam shutter)

The RT-5SW features electronic beam “masking” to prevent the beam from transmitting on one or multiple sides of the instrument. Due to the long beam range of the RT-5SW, this can be useful to eliminate duplicate laser beams on large job sites where more than one laser may be in use. The use of masking has no effect on power usage.

- 1** Press the Mask key on the RC-300W.
With no masking active the display will be as shown.
- 2** Select one or more directions to mask by pressing the arrow keys (Y+, X-, Y-, X+).
Each press repeats activating/releasing the mask.
- 3** When desired masking is displayed, press the [ENT] key to finish.
Confirm the [OK] mark on the display. If the [NG] mark is displayed, press [ENT] again.

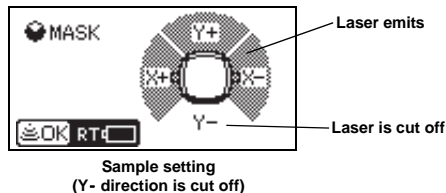
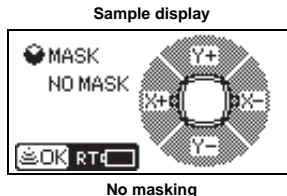

Change the masking mode

Mode 1

As seen
from above

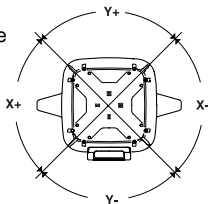

You can select a masking mode among two modes as shown above.

Mode 2

As seen
from above

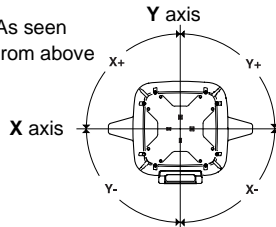

To Set the Masking

You can set the masking by pressing the Mask Key in the same manner as before.

The arrow keys (Y+, X-, Y-, X+) are related with the masking directions as shown in above figures.

Sample display

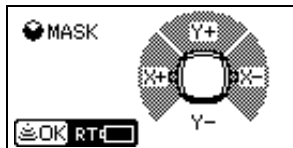

Mode 1



Mode 2

Displaying selected masking mode

Selected masking mode will be indicated on the main display.



Selected masking mode



How to select the masking mode

The masking mode can be selected on page 2 of function mode.

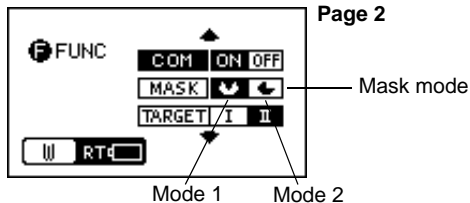

Function Mode

The RT-5SW has seven function modes the user can set.

- 1) Laser Output Power (POWER) 2) Sensitivity Level (LEVEL) 3) Height Alert (ALERT)
4) Alarm Signal (COM) 5) Changing Masking Mode 6) Setting the target
7) Channel Setting**

1) Laser Output Power (POWER)

Two levels of laser output are possible:

HIGH (4.5mW) LO (2.5mW)

The high power mode should be used when necessary due to long range requirement, otherwise the low power mode will provide longer battery life.

2) Sensitivity Level (LEVEL)

The sensitivity mode allows the user to select the vibration level that is necessary to cause the unit to re-activate auto-leveling. This function is valuable when the RT-5SW in windy or other conditions that cause unnecessary auto-leveling activity.

Two sensitivity levels can be set, plus manual operation.

Level One [1]: Least sensitive. Auto-leveling will not activate with moderate vibration.

Level Two [2]: Most sensitive. Smallest vibration will cause auto-leveling activity.

M(Manual): Auto-leveling function, Auto-alignment and Setting grade are turned off.



Do not use manual level [M] except for special circumstances. If manual [M] is selected, the Automatic alignment, Automatic grade setting and X,Y-grade setting function will not operate and leveling and grade setting precision cannot be assured.

3) Height Alert Function (ALERT)

When active, the Height Alert function will not allow the RT-5SW to continue operating if the unit is disturbed after it has auto-leveled. This reminds the user that to insure accurate control. (When COM is ON)

ON: Height Alert active OFF: Height Alert inactive

4) Alarm Signal (COM)

When used with the Topcon LS-70A laser sensor, the RT-5SW can communicate alarm signals directly to the sensor. This helps enable the user to be completely aware of potential problems before they can become serious.

ON: Alarm Signal is active OFF: Alarm Signal is inactive

When Alarm Signal is active, the LS-70A will notify the user of any Height Alert and the battery status of the RT-5SW.

5) Changing Masking Mode

Change the masking mode.

(Refer to "Change the masking mode" on page 31.)

6) Setting the Target

Select a target.

I: Target that comes with the RT-5Sa

II: Target that comes with the RT-5SW

When the above target I is used, the Automatic grade setting is not possible.

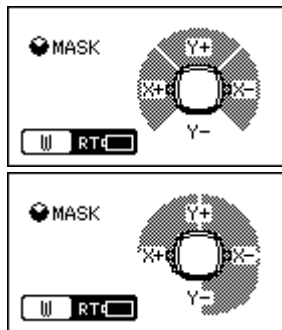

7) Channel Setting

Set the channel of RT-5SW (only RC-300W attached to RT-5SW. In this case, the channel on the instrument and remote controller is changed.)

- 1 Press the [F] key to enter Function Mode. Use the arrow key(up and down) to select the display as shown.
- 2 Use the arrow key(right and left) to select the desired channel, then press the [ENT] key to finish.

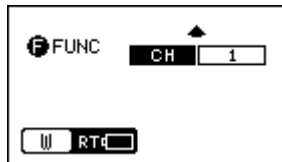

Set the channel of RC-300W (only RC-300W detached from RT-5SW)

[Making a change directly]

- 1 Hold down the [F] key for 2 seconds or more to display the channel selection screen.
- 2 Press the arrow key(up and down) to select [DIRECT], then press the [ENT] key to finish.
- 3 Press the arrow key (up and down) to show the channel you want to select and then press the [ENT] key to establish that channel.



[Making a change by searching]

- 1** Hold down the [F] key for 2 seconds or more to display the channel selection screen.
- 2** Use the arrow key (up and down) to select [SEARCH] and then press the [ENT] key.
- 3** Search for the channels available on the active or standing by RT-5SW.



After the search is finished, hit channels will be displayed.

- 4** Use the arrow key (up and down) to position the cursor on the channel you want to select and then press the [ENT] key to establish that channel.



How to set the options

In the Function Mode [F] there are three display screens on the RC-300W as shown. Use the arrow keys to scroll to each screen and select items.

- 1 Press the [F] key to enter Function Mode. The current setting for the instrument will be displayed.
- 2 Select an item (Power, Level, Alert, Com, Mask, Target, CH) by pressing the Up or Down arrow keys.
- 3 After the desired item is selected, use the Right and Left arrow keys to select the desired setting.

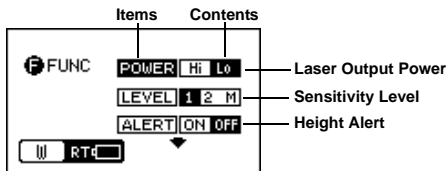

Page 1

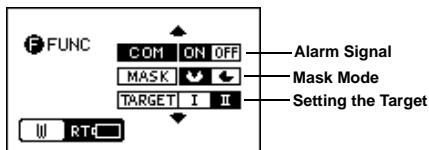

Page 2

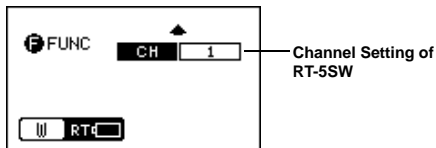

Page 3

- 4** Press the [ENT] key to set.
Confirm the [OK] mark on the display.
If the [NG] mark is displayed, press [ENT] again.
- 5** Select and change other items by repeating the procedure.

Maintaining Power Sources

RC-300W

Make sure the RC-300W is off or is not active(auto cut off) before replacing its batteries.

How to replace the RC-300W batteries

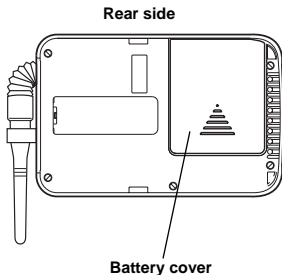

- 1** Remove the RC-300W from the RT-5SW.
- 2** Remove the battery cover from the back of the RC-300W by pressing on the cover and sliding it in the direction of the arrow.
- 3** Remove the old batteries and replace with four (4) new AA alkaline batteries making sure each is placed in the proper direction as indicated.
- 4** Replace the battery cover. You will hear a click when it snaps in place.



Replace all 4 batteries with new ones.
Do not mix old batteries and new ones.

RT-5SW



After replacing the batteries in the RT-5SW, re-attach the RC-300W once (if it was detached during battery replacement) to re-enter the status of the RT-5SW into the RC-300W.

Dry battery

How to replace dry batteries

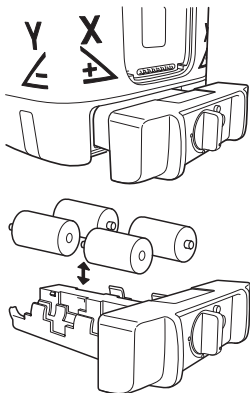

- 1** Remove the battery cover by turning the battery cover knob to “OPEN”.
- 2** Remove the old batteries and replace with four (4) new “D” cell alkaline batteries making sure each is placed in the proper direction as indicated.
- 3** Replace the battery cover and turn the knob to “LOCK”.



Replace all 4 batteries with new ones.
Do not mix old batteries and new ones.

Rechargeable battery

Installing

- 1 Insert Ni-MH BT-63Q battery pack into the DB-64C battery holder.
- 2 Insert the battery pack into the instrument and turn the battery cover knob to “LOCK”.

Charging

- 1 Plug the AC/DC converter (AD-9B or AD-7C) into the DB-64C battery holder.
- 2 Plug the converter power cord into the appropriate AC outlet (120v AC for AD-9B converter, 230v AC for AD-7C converter)
- 3 When charging is complete (after approximately nine hours), unplug the converter from the connector on the DB-64C battery holder.
- 4 Unplug the converter power cord from the AC receptacle.

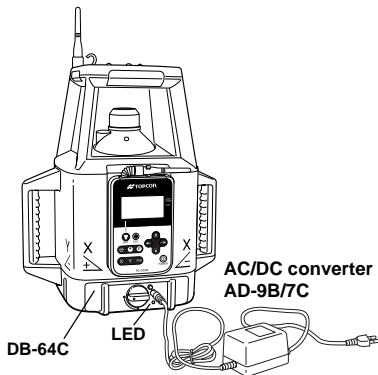

The LED of DB-64C will indicate charging status:

Red ON : Charging.

Green ON : Charging completed.

Green flashing : Ni-MH BT-63Q battery pack is not installed correctly.

Red flashing : Ni-MH BT-63Q battery pack protection feature is working automatically.

RT-5SW can be used in this state.

Automatic protection feature; In case of overcharge or high or low temperature state exceeding charging range, charging will be stopped or changed to protect Ni-MH battery.



- 1) The Ni-MH BT-63Q rechargeable battery can be charged while using the laser.
- 2) The Ni-MH BT-63Q rechargeable battery can be charged when the battery holder is removed from the instrument. This allows the option of alternately using two battery packs to always maintain a fully charged pack.
- 3) The Ni-MH BT-63Q rechargeable battery can be removed from the DB-64C battery holder and four "D" cell alkaline batteries can be installed.
- 4) The DB-64 dry cell battery holder cannot be used to charge the BT-63Q Ni-MH battery pack. Use the DB-64C charging battery holder instead.

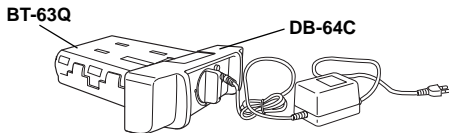

- 1) Recharging should take place in a room with an ambient temperature range of 10°C to 40°C (50°F to 104°F).
- 2) The battery source will discharge when stored and should be checked before using with instrument.
- 3) Be sure to charge stored battery source every 3 or 6 months and store in a place at 30°C or below.
If you allow the battery to become completely discharged, it will have an effect on future charging.

Check and Adjusting

There are three areas of performance the user should check periodically.

Horizontal Calibration

Horizontal Rotation Cone

Grade Setting

The Horizontal Calibration can be easily checked and, in most cases, adjustments made by the user. Both Horizontal Rotation Cone and Grade Setting can be checked by the user, but should an error be found, adjustments must be made by a Topcon service facility.

Horizontal Calibration



Always be sure the RC-300W is within two-way communication while checking and adjusting the instrument. If the RC-300W displays error code [COM ERR TURN OFF / TURN ON] any time during the procedure, turn the instrument OFF and ON again and repeat the procedure from the beginning.

(1) Checking Calibration

- 1 Set up a tripod 50m(164ft) from a staff or wall. Mount the instrument on the tripod, facing the “X-” axis toward the staff/wall.
- 2 Remove the RC-300W from the instrument.
- 3 While pressing the Function [F] key of the RC-300W press the power switch to turn on the instrument. This activates the calibration mode.

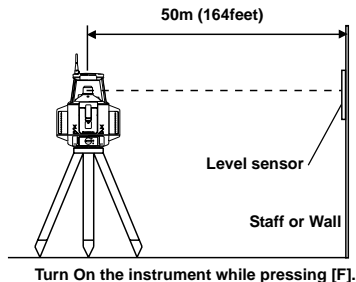

X: Y:

- 4 Select the axis you wish to check (X or Y) by press the [X] or [Y] key. Press the [ENT] key. (These instructions will assume the X axis was chosen.)



The RT-5SW will automatically rotate internally to orient the axis selected to the staff/wall. It is not necessary to manually rotate the instrument any time during the procedure. Therefore calibration checking and adjusting is much faster and easier than the user may have experienced with other instruments.

After communication between the RT-5SW and the RC-300W is complete, the unit will automatically adjust to the position selected and auto-leveling will start. The yellow LED on the instrument will flash. When auto-leveling is complete, the rotary head will rotate and emit the laser. The RC-300W will display "X:1".

- 5 Turn on the LS-70A laser sensor, and select fine detection mode.
- 6 Use the LS-70A to detect the laser beam on the staff/wall. Move the sensor up or down until the LCD indicator and audio signal identifies the center of the laser beam. Fix the LS-70A in that position on the staff or wall.

Select an axis and press [ENT].

X:



RC-300W display will show axis selected, and RT-5SW will automatically position the axis in the proper direction.



X:1



Detect the laser on the staff or wall.

Move the level sensor up and down until the indicator and sound identifies the center of the laser beam.

Then fix the sensor.

- 7 Press the [ENT] key on the RC-300W. The unit will rotate 180 degrees internally and start auto-leveling. The RC-300W will now display “X:2”.

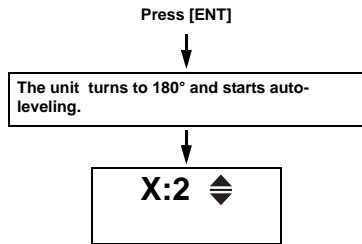

- 8 When the rotary head starts rotating, do not move the LS-70A laser sensor to locate the beam center. Instead, note the beam location as shown on the laser sensor display. If one of the three center LCD indicators is lit (center bar, Down arrow-point, Up arrow-point) calibration is OK and no adjustment is needed. Repeat steps 4-8 for the remaining axis (Y in this example).



Note the position of the X2 laser beam on the LS-70A display. If one of the three center indicators is lit, no calibration adjustment is necessary.

If adjustment is necessary proceed to the “Adjusting” instructions below before checking the remaining axis.

(2) Adjusting Calibration

- 1 By pressing the UP or DOWN arrow keys on the RC-300W, move the rotating laser beam up or down as necessary until the center bar on the LS-70A display is lit. (This will be the same position as center of “X:1” and “X:2”.)

While the beam is moving, RC-300W displays “ADJUSTING”.

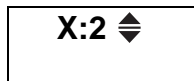

Move the X2 rotating laser until the center bar of the LS-70A display is lit.

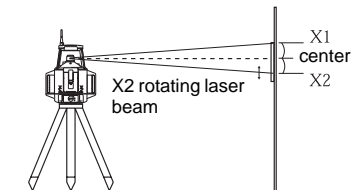

- 2 When the center bar lit on the LS-70A, press the [ENT] key on the RC-300W. The correction value will be calculated by the RT-5SW and transmitted to the RC-300W. When the transmission is completed, the display shows “PUSH (ent) KEY”.

When the center bar is lit, press [ENT].

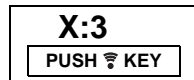

Confirm the value, press [ENT].

3 Press the [ENT] key to complete the calibration.

The RC-300W display will return to the axis selection screen.

If an axis remains to be checked, begin at step 4 of “Checking Calibration”.

4 To complete the calibration procedure, press the power switch to turn the instrument off.

X: Y:

Turn the instrument OFF to finish the calibration.



In order to perform the Automatic grade setting more accurately, it is recommended that the error be adjusted within ± 2 mm.



If the correction value calculated exceeds the allowable range, the RC-300W will display error code [CAL LIMIT]. Check the procedure again and perform any inspections and adjustments.

Horizontal Rotation Cone Error

Perform the following check after completing “Horizontal Calibration” on the previous page.

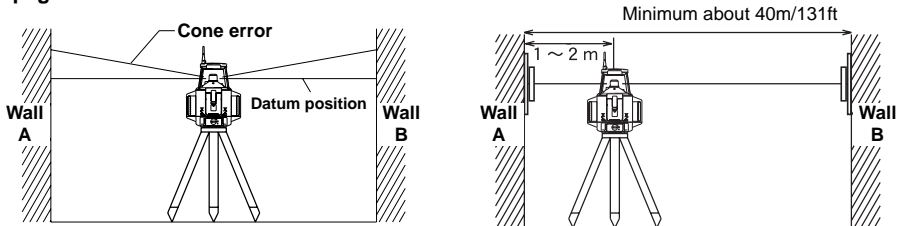

- 1 Set up the laser centered between two walls approximately 40m (131 ft) apart. Orient the instrument so one axis, either X or Y, is facing the walls. Grade should be set to 0.00% in both axes.
- 2 Locate and mark the position of the rotating laser beam on both walls using the LS-70A laser sensor.
- 3 Turn off the instrument and move the instrument closer to wall A (1m to 2m / 3 ft to 6 ft). Do not change the axis orientation of the instrument. Turn the instrument on.
- 4 Again locate and mark the position of the rotating laser beam on both walls using the LS-70A laser sensor.
- 5 Measure the distance between the first and second marks on each wall.
- 6 If the difference between each set of marks is less than $\pm 4\text{mm}$ ($\pm 5/32$ of an inch), no error exists.



If the difference between [wall A]-side and [wall B]-side exceeds $\pm 4\text{mm}$ ($\pm 5/32$ of an inch), contact your dealer or Topcon.

Grade Setting Error

Perform the following check only after completing “Horizontal Calibration” and “Horizontal Rotation Cone Error”.

(1) Checking



Due to the accuracy required to perform this check, the staff used in this procedure must be graduated in millimeters.

- 1 Securely position two nails or stakes exactly 30m (93 ft) apart. These positions will be called Nail 1 and Nail 2.

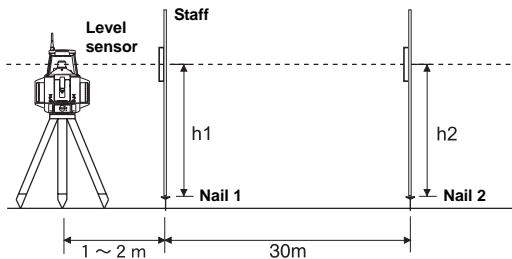

- 2 Set up the instrument on a tripod approximately 1m to 2m (3 ft to 6 ft) in front of Nail 1 on the line created by Nail 1 and Nail 2. Position the instrument so the “X-” axis is directly on the line created by Nail 1 and Nail 2.
- 3 Turn on the instrument and verify the grade setting is 0.00% in both axes. Turn on the LS-70A laser sensor and set it to high precision detection. Using the staff, read the elevation of the laser beam in millimeters at Nail 1 and Nail 2. Designate the elevation at Nail 1 as “h1”, at Nail 2 as “h2”.

- 4 Set X axis grade to 1.00%. Align read the elevation of the laser beam in millimeters at Nail 1 and Nail 2. Designate these elevations as “h3” at Nail 1, and “h4” at Nail 2.

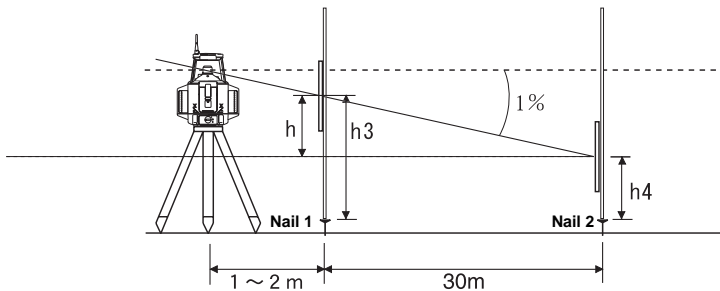

- 5 Using the elevation readings for h1, h2, h3 and h4, complete the equation below.

$$x(\%) = \frac{h}{30000(\text{mm})} \times 100 = \frac{(h_2 - h_4) - (h_1 - h_3)}{30000} \times 100$$

If the calculated result is the range of 0.990% - 1.010%, the instrument is normal.

Repeat the procedure aligning the “Y-” axis on the line created by Nail 1 and Nail 2.



If the calculated result for either axis is out of the range, contact your dealer or Topcon.

Example; h1 = 1370; h2 = 1390; h3 = 1362; h4 = 1080

$$X\% = \frac{(1390 - 1080) - (1370 - 1362)}{30000} \times 100 = 0.010066 \times 100 = 1.006\%$$

The X axis of instrument is normal because 1.006 is within the range 0.990 to 1.010.

Storage Precautions

Always clean the instrument after use.

Use a clean cloth, moistened with a neutral detergent or water. Never use an abrasive cleaner, ether, thinner benzene or other solvents.

Always make sure instrument is completely dry before storing. Dry any moisture with a soft, clean cloth.

Store with the batteries removed, when operation is halted for more than a month.

Standard / Optional Accessories

Level sensor holder model 6

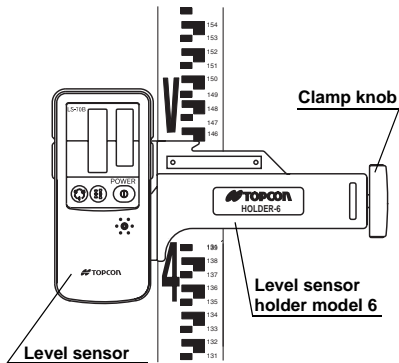

Level sensor holder model 5

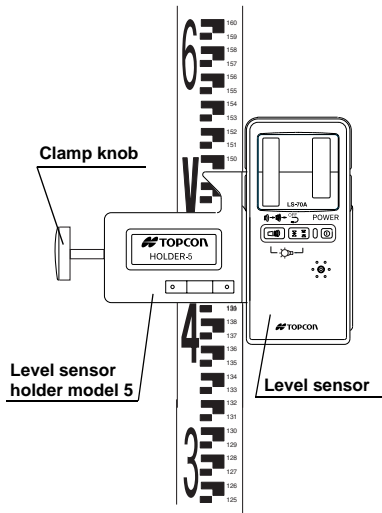

Holder Model 5 allows the laser sensor to be moved up or down on the staff by squeezing the spring-loaded clamp on its back side without removing the sensor from the staff.

Level sensor holder model 3

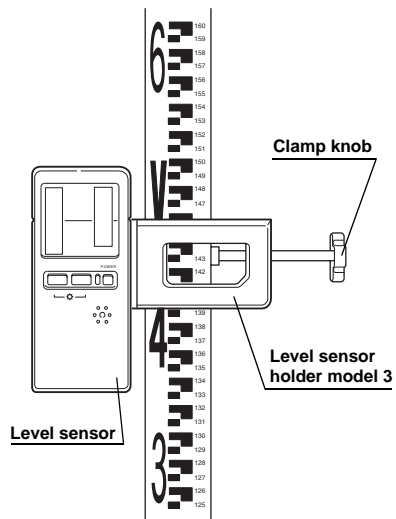

LS-70A Laser Sensor

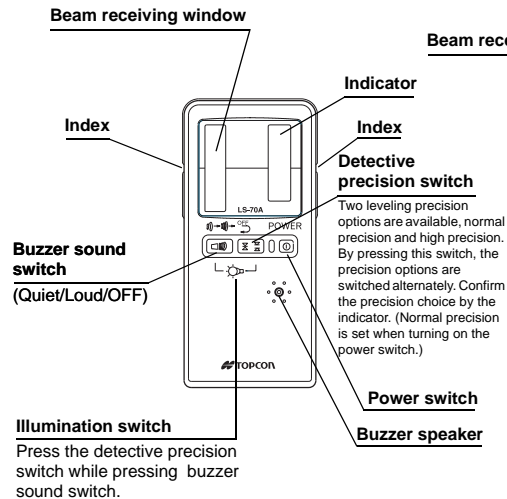

LS-70B Laser Sensor

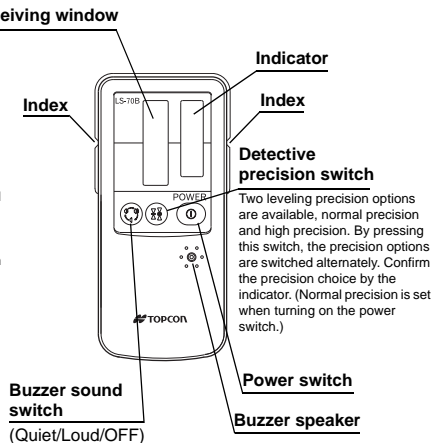

Auto-cut off function (LS-70A and LS-70B)





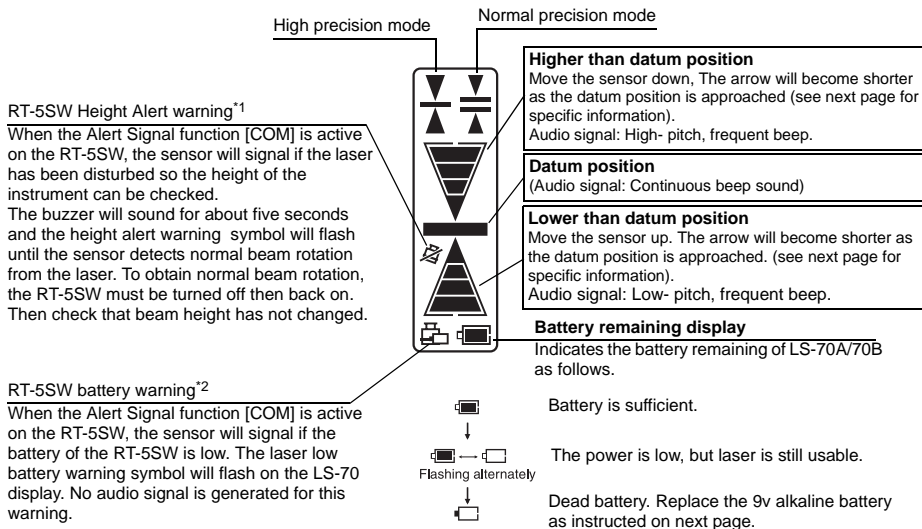





The power will be turned off automatically if no laser beam is detected within approximately 30 minutes. (To turn the sensor on again, press the power switch.)

Display (LS-70A/70B)



The warning signal *1 and *2 will function only if RT-5SW Alert Signal function [COM] is active. See "Function Mode" section earlier in this manual. Alarm detection at the LS-70 can be canceled by turning off the LS-70, then turning it back on while pressing the buzzer sound switch.

Detective range (LS-70A/70B)

Display \ Mode	HIGH ▼▲	NORMAL ▼▲
	LS-70A $\pm 1\text{mm}/\pm 0.0032\text{ ft}$ (2mm/.0064 ft width)	$\pm 2\text{mm}/\pm 0.0064\text{ ft}$ (4mm/.013 ft width)
	LS-70B $\pm 1\text{mm}/\pm 0.0032\text{ ft}$ (2mm/.0064 ft width)	
 	$\pm 5\text{mm}/\pm 0.16\text{ ft}$ (10mm/.032 ft width)	
 	$\pm 10\text{mm}/\pm 0.33\text{ ft}$ (20mm/.066 ft width)	
 	$\pm 15\text{mm}/\pm 0.05\text{ ft}$ (30mm/.010 ft width)	
 	More than $\pm 15\text{mm}/.05\text{ ft}$	
 	Laser sensor has been moved above or below the laser beam. Move sensor in direction of arrow to receive laser.	

Replacing Battery (LS-70A/70B)

- 1 Press the lid in the direction of the arrow to lift.
- 2 Remove the battery and replace with a new 9v alkaline battery.
- 3 Press the lid down and click to close.



Remote display with coil cord (LS-70A only)

Optional remote display connects to the back of the LS-70A. The remote LCD display can be positioned up to 5m (16 ft) from the laser sensor.

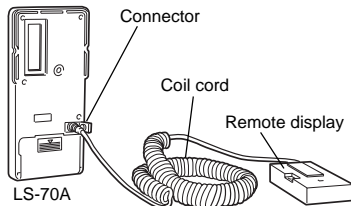

Specifications

RT-5SW

Accuracy (reproducibility)	: $\pm 5''$
Auto-leveling range	: $\pm 5^\circ$
Measuring range (Diameter)	: Approx. 2 - 1200m (6 - 4000 ft) with LS-70A/B sensor
Rotation speeds	: 300/600/900 rpm (Changeable)
Light source	: L.D (Visible laser)
Power supply	: 4D-CELL dry batteries (DC6V) Ni-MH battery pack BT-63Q (It can be charged while using it.)
Continuous operating time	Alkaline manganese dry battery : Approx. 45 hours Ni-MH battery pack BT-63Q : Approx. 30 hours
Tripod screw	: Flat and dome head type, 5"/8X11 threads
Water proof construction	: IPX6 (Based on the standard IEC60529)
Operating temperature	: $-20^\circ\text{C} \sim +50^\circ\text{C}$ ($-4^\circ\text{F} \sim +122^\circ\text{F}$)
Dimensions	: 203(L)X286(W)X352(H) mm [8.0(L)X11.3(W)X13.8(H) in]
Weight	: 8.1kg (17.8lbs) (Dry battery type:Including dry batteries) 8.2kg (18.0lbs) (Ni-MH battery type:Including BT-63Q)

RC-300W

Continuous operating time	Alkaline manganese dry battery : Approx. 3 months
Operating distance	: Approx. 300m

LS-70A

Detective range : 50mm (2.0 in)

Detective precision

High precision : $\pm 1\text{mm}(\pm 0.04\text{ in})$

Normal precision : $\pm 2\text{mm}(\pm 0.08\text{ in})$

Detective beam indication

Liquid crystal and buzzer

Power source

DC 9V dry battery

The time for auto-cut off

Approx. 30 min.

Operating temperature

$-20^{\circ}\text{C}\sim+50^{\circ}\text{C}$ ($-4^{\circ}\text{F}\sim+122^{\circ}\text{F}$)

Continuous operating time

Alkaline manganese dry battery
Approx.80hours

Dimensions

167(l)x78(w)x27(h) mm

(6.6(l)x3.1(w)x1.1(h) in)

Weight

0.25 kg (0.55 lbs)

(including a dry battery)

Remote display connector**LS-70B**

Detective range : 50mm (2.0 in)

Detective precision

High precision : $\pm 1\text{mm}(\pm 0.04\text{ in})$

Normal precision : $\pm 2\text{mm}(\pm 0.08\text{ in})$

Detective beam indication

Liquid crystal and buzzer

Power source

DC 9V dry battery

The time for auto-cut off

Approx. 30 min.

Operating temperature

$-20^{\circ}\text{C}\sim+50^{\circ}\text{C}$ ($-4^{\circ}\text{F}\sim+122^{\circ}\text{F}$)

Continuous operating time

Alkaline manganese dry battery
Approx.80hours

Dimensions

165(l)x78(w)x26(h) mm

(6.5(l)x3.1(w)x1.0(h) in)

Weight

0.25 kg (0.55 lbs)

(including a dry battery)

Error Display

Error code	Description	Countermeasure
RT BATT LOW	The battery of the RT-5SW is dead.	Replace or recharge the batteries. If replaced, return the RC-300W to the RT-5SW after new batteries are installed.
HI ALERT	The height alert function is working.	Turn the power key OFF and ON again, the auto-leveling function will start again.
LEVELING RANGE LIMIT	The instrument is inclined more than the auto-leveling range.	Set up the instrument within the ± 5 degree auto-leveling range.
CAL LIMIT	In the checking and adjusting mode, the correction value is out of range.	Turn the power key OFF and ON again, repeat from the beginning.
E-05	The rotary head can not rotate for some reason.	Turn the power key OFF and ON again.
RETRY	The instrument can not find the target in the Automatic alignment/Automatic grade setting mode.	Confirm the target or setting direction of the instrument, repeat from the beginning.
RETRY RANGE LIMIT	The location where the target is placed exceeds the measuring range during Automatic alignment and Automatic grade setting.	Confirm the target or setting direction of the instrument, repeat from the beginning.
E-40's E-90's	Abnormality in internal memory of the instrument.	Turn the power key OFF and ON again.

Error code	Description	Countermeasure
RC BATT LOW	The battery of the RC-300W is dead.	Replace the batteries with new ones after turning off the RC-300W.
E-51 E-52	Abnormality in internal memory of the RC-300W.	RC-300 can be used, but auto-cut off will not function.
E-60's	Abnormality has occurred with encoder system.	Turn the power key OFF and ON again.
E-70's	Abnormality has occurred with internal communication.	Turn the power key OFF and ON again.
E-80's	Leveling has not been completed.	Turn the power key OFF and ON again.
TURN OFF/ TURN ON	Occurs when transmitting between the RT-5SW and RC-300W in the checking and adjusting mode.	Turn the power key OFF and ON again, repeat from the beginning.
ONLY RT CONNECTION	Abnormality in the wireless module of the RC-300W.	Operate the RC-300W attached to the RT-5SW.

If errors still persist after attempting to clear them, contact Topcon or your dealer.



TOPCON POSITIONING SYSTEMS, INC.

7400 National Drive, Livermore, CA 94551, U.S.A.
Phone: 925-245-8300 Fax: 925-245-8599 www.topcon.com

TOPCON CALIFORNIA

3380 Industrial Blvd, Suite 105, West Sacramento, CA 95691, U.S.A.
Phone: 916-374-8575 Fax: 916-374-8329

TOPCON EUROPE POSITIONING B.V.

Essebaan 11, 2908 LJ Capelle a/d IJssel, The Netherlands.
Phone: 010-458-5077 Fax: 010-284-4949 www.topconeurope.com

IRELAND OFFICE

Unit 69 Western Parkway Business Center
Lower Ballymount Road, Dublin 12, Ireland
Phone: 01460-0021 Fax: 01460-0129

TOPCON DEUTSCHLAND G.m.b.H.

Giesslerallee 31, 47877 Willich, GERMANY
Phone: 02154-885-100 Fax: 02154-885-111 info@topcon.de
www.topcon.de

TOPCON S.A.R.L.

89, Rue de Paris, 92585 Clichy, Cedex, France.
Phone: 33-1-41069490 Fax: 33-1-47390251 topcon@topcon.fr

TOPCON ESPAÑA S.A.

Frederic Mompou 5, ED. Euro 3, 08960, Sant Just Desvern, Barcelona, Spain.
Phone: 93-473-4057 Fax: 93-473-3932 www.topconesp.com

TOPCON SCANDINAVIA A. B.

Neogatan 2 S-43151 Mölndal, SWEDEN
Phone: 031-7109200 Fax: 031-7109249

TOPCON (GREAT BRITAIN) LTD.

Topcon House Kennet Side, Bone Lane, Newbury, Berkshire RG14 5PX U.K.
Phone: 44-1635-551120 Fax: 44-1635-551170
survey.sales@topcon.co.uk laser.sales@topcon.co.uk

TOPCON SOUTH ASIA PTE. LTD.

Blk 192 Pandan Loop, #07-01 Pantech Industrial Complex, Singapore 128381
Phone: 62780222 Fax: 62733540 www.topcon.com.sg

TOPCON AUSTRALIA PTY. LTD.

Unit 18, 4 Avenue of Americas Newington NSW 2127, Australia
Phone: 02-8748-8777 Fax: 02-9647-2926 www.topcon.com.au

TOPCON INSTRUMENTS (THAILAND) CO., LTD.

77/162 Sinn Sathorn Tower, 37th Fl.,
Krungthongburi Rd., Klongtong Sai, Klongsarn, Bangkok 10600 Thailand.
Phone: 02-440-1152~7 Fax: 02-440-1158

TOPCON INSTRUMENTS (MALAYSIA) SDN. BHD.

Excella Business Park Block C, Ground & 1st Floor, Jalan Ampang Putra,
Taman Ampang Hilir, 55100 Kuala Lumpur, MALAYSIA
Phone: 03-42701068 Fax: 03-42704508

TOPCON KOREA CORPORATION

2F Yooseoung Bldg., 1595-3, Seocho-Dong, Seocho-gu, Seoul, 137-876, Korea.
Phone: 82-2-2055-0321 Fax: 82-2-2055-0319 www.topcon.co.kr

TOPCON OPTICAL (H.K.) LIMITED

2-4/F Meeco Industrial Bldg., No. 53-55 Au Pui Wan Street, Fo Tan Road,
Shatin, N.T., Hong Kong
Phone: 2690-1328 Fax: 2690-2221 www.topcon.com.hk

TOPCON CORPORATION BEIJING OFFICE

Building A No.9, Kangding Street
Beijing Economic Technological Development Area, Beijing, China 100176
Phone: 10-6780-2799 Fax: 10-6780-2790

TOPCON CORPORATION BEIRUT OFFICE

P. O. BOX 70-1002 Antelias, BEIRUT-LEBANON.
Phone: 961-4-523525/961-4-523526 Fax: 961-4-521119

TOPCON CORPORATION DUBAI OFFICE

C/O Atlas Medical FZCO., P. O. Box 54304, C-25, Dubai Airport Free Zone, UAE
Phone: 971-4-2995900 Fax: 971-4-2995901

TOPCON CORPORATION

75-1 Hasunuma-cho, Itabashi-ku, Tokyo 174-8580, Japan
Phone: 3-3558-2520 Fax: 3-3960-4214 www.topcon.co.jp